

**PROMO 2020**



**GIGLI & MASSIMO**  
ITALY

# Salon Chairs



GIGLI & MASSIMO  
ITALY

# AURORA GM14

Poltrona lavoro rivestita in skay completa di base rotonda in acciaio e pompa idraulica con il blocco.

Styling chair covered in skay, complete of steel round base with hydraulic pump with the block.

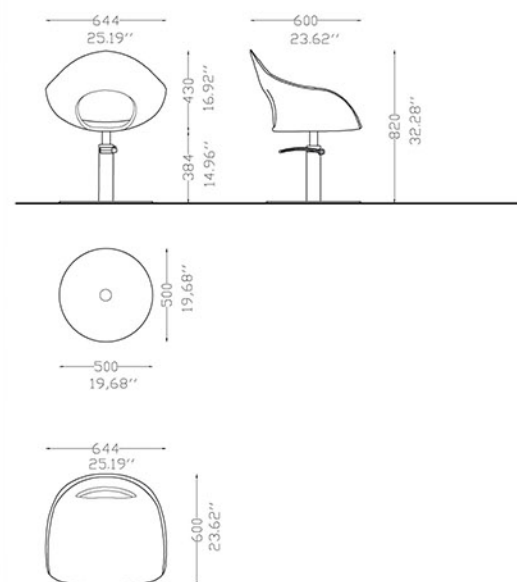

Poltrona lavoro completa di base acciaio inox tonda o quadra e pompa con blocco

**PROMO 2020**

~~€ 1130,00~~

**€ 735,00\***

**-35%**

\*incluso imballo, trasporto escluso

## Colori Ecopelle



**Nero**  
cod. 00991



**Bianco**  
cod. 00006

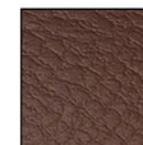

**Marrone**  
cod. 01306

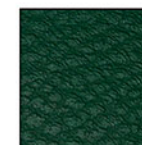

**Verde**  
cod. 01831



**Beige**  
cod. 00151

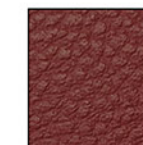

**Bordeaux**  
cod. 00726

# ALLURE GM18

Poltrona lavoro rivestita in skay completa di base quadra in acciaio e pompa idraulica con il blocco.

Styling chair covered in skay, complete of steel round base with hydraulic pump with the block.

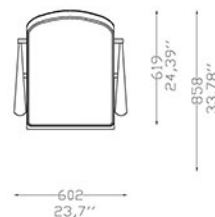
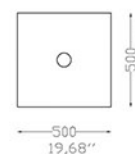
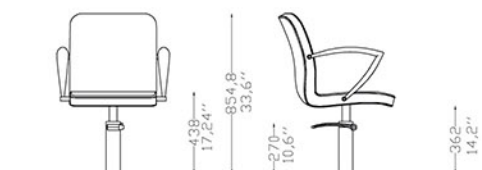

Poltrona lavoro completa di base acciaio inox tonda o quadra e pompa con blocco

**PROMO 2020**

~~€ 995,00~~

**€ 647,00\***

**-35%**

\*incluso imballo, trasporto escluso

## Colori Ecopelle



**Nero**  
cod. 00991



**Bianco**  
cod. 00006

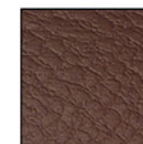

**Marrone**  
cod. 01306

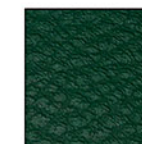

**Verde**  
cod. 01831



**Beige**  
cod. 00151

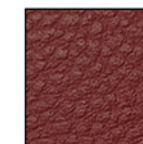

**Bordeaux**  
cod. 00726

# FOXI GM12

Poltrona lavoro rivestita in skay completa di base rotonda in acciaio e pompa idraulica con il blocco.

Styling chair covered in skay, complete of steel round base with hydraulic pump with the block.

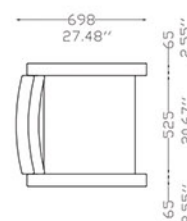
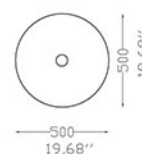
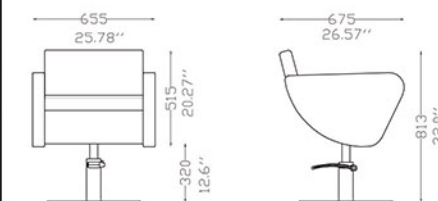

Poltrona lavoro completa di base acciaio inox tonda o quadra e pompa con blocco

**PROMO 2020**

~~€ 1305,00~~

**€ 849,00\***

**-35%**

\*incluso imballo, trasporto escluso

## Colori Ecopelle



**Nero**  
cod. 00991



**Bianco**  
cod. 00006

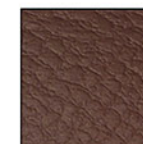

**Marrone**  
cod. 01306

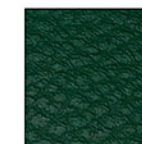

**Verde**  
cod. 01831



**Beige**  
cod. 00151

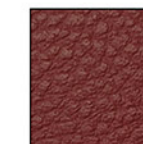

**Bordeaux**  
cod. 00726

# OLIVIA GM19

Poltrona lavoro rivestita in skay completa di base rotonda in acciaio e pompa idraulica con il blocco.

Styling chair covered in skay, complete of steel round base with hydraulic pump with the block.

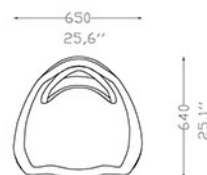
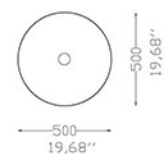
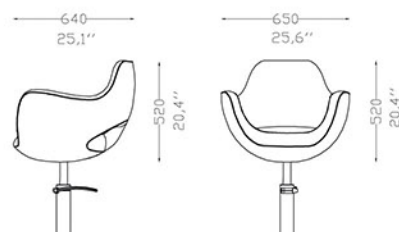

Poltrona lavoro completa di base acciaio inox tonda e pompa con blocco

**PROMO 2020**

~~€ 1405,00~~

**€ 914,00\***

**-35%**

\*incluso imballo, trasporto escluso consegna 90 GG. salvo diversa comunicazione

Colori Ecopelle

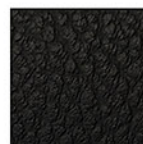

**Nero**  
cod. 00991

Colori Bordo



**Bianco**  
cod. 00006



# Wash Units



GIGLI & MASSIMO  
ITALY

## CORAL GM 32

Mobile lavaggio con struttura in legno rivestita in skay, completo di lavandino con il gruppo miscelatore.

Shampoo unit with wood structure covered in skay, complete of the white washbasin with mixer.

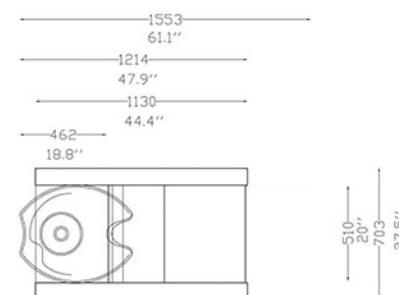
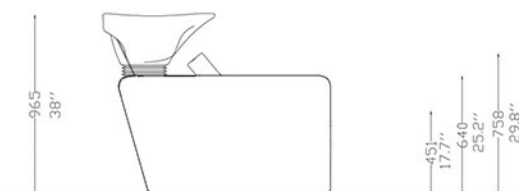

Mobile lavaggio completo di lavandino e gruppo miscelatore

**PROMO 2020**

~~€ 2665,00~~

**€ 1733,00\***

**-35%**

\*incluso imballo, trasporto escluso  
possibilità di avere lavandino nero

### Colori Lavandino



Bianco



Nero

### Colori Ecopelle



Nero  
cod. 00991



Bianco  
cod. 00006

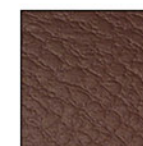

Marrone  
cod. 01306

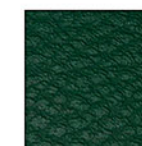

Verde  
cod. 01831



Beige  
cod. 00151

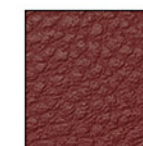

Bordeaux  
cod. 00726



## SHORE GM 31

Mobile lavaggio con struttura in metallo laccato bianco e nero, poltrona rivestita in sky, completo di lavandino con il gruppo miscelatore.

Shampoo unit made in iron painted in black and white colors, chair covered in fire protection vinyl, complete of washbasin with mixer.

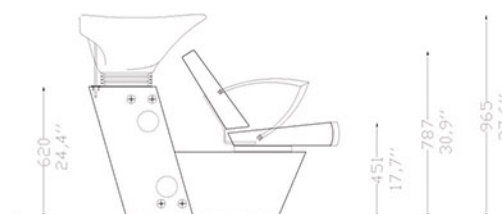

1222  
48,11"

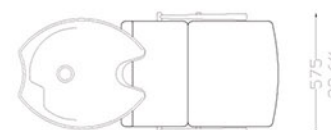

1222  
48,11"  
48,11"

Mobile lavaggio completo di lavandino e gruppo miscelatore

**PROMO 2020**

~~€ 1895,00~~

**€ 1232,00\***

**35%**

\*incluso imballo, trasporto escluso  
possibilità di avere lavandino nero

### Colori Lavandino



Bianco



Nero

### Colori Ecopelle



Nero  
cod. 00991



Bianco  
cod. 00006

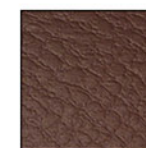

Marrone  
cod. 01306

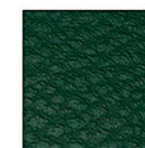

Verde  
cod. 01831



Beige  
cod. 00151



Bordeaux  
cod. 00726

# WAVE GM 34

Mobile lavaggio con struttura in legno rivestita in skay, completo di lavandino con il gruppo miscelatore.

Shampoo unit with wood structure covered in skay, complete of the white washbasin with mixer.

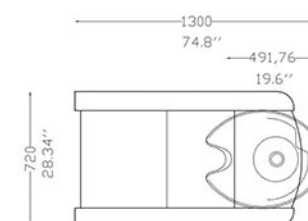
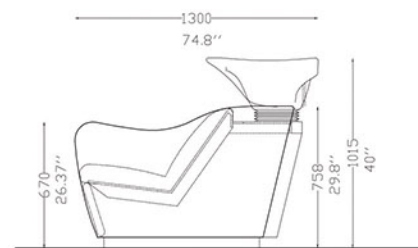

Mobile lavaggio completo di lavandino e gruppo miscelatore

**PROMO 2020**

~~€ 2790,00~~

**€ 1814,00\***

**-35%**

\*incluso imballo, trasporto escluso  
possibilità di avere lavandino nero

## Colori Lavandino



Bianco



Nero

## Colori Ecopelle



Nero  
cod. 00991



Bianco  
cod. 00006



Marrone  
cod. 01306

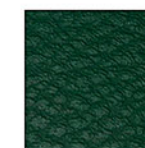

Verde  
cod. 01831



Beige  
cod. 00151



Bordeaux  
cod. 00726

## FIJI RELAX GM40

Mobile lavaggio chease lounge con struttura rivestita in sky, lavandino colore bianco con movimentazione elettrica e gruppo miscelatore. Completo di pouf di servizio su ruote e illuminazione RGB sottoscocca.

Wash unit chaise lounge with structure covered in sky, white sink with electric movement and mixer unit. Complete with service pouf on wheels and underbody RGB lighting.

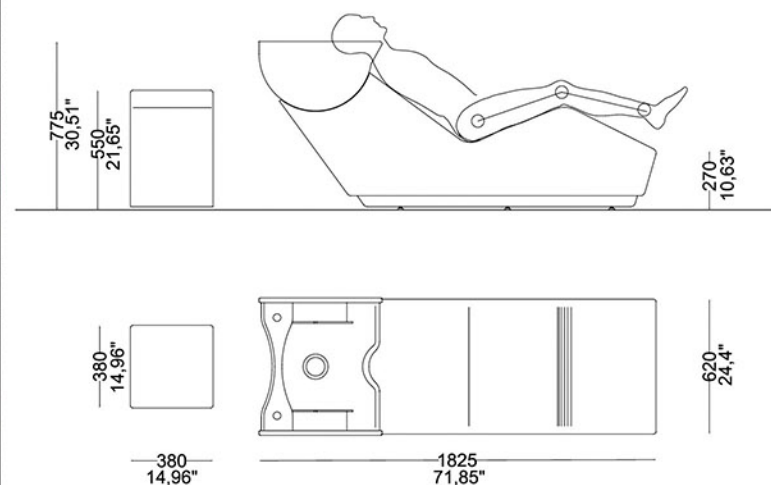

Mobile lavaggio completo di lavandino con gruppo miscelatore, pouf di servizio su ruote e led RGB

**PROMO 2020**

~~€ 4970,00~~

**€ 3230,00\***

**-35%**

\*incluso imballo, trasporto escluso

Colori Ecopelle



Nero  
cod. 00991



Bianco  
cod. 00006

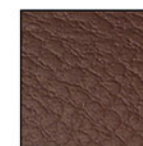

Marrone  
cod. 01306

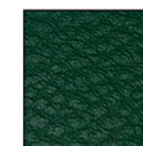

Verde  
cod. 01831

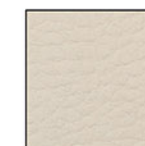

Beige  
cod. 00151



Bordeaux  
cod. 00726

# CENTO GM39

Mobile lavaggio con struttura in acciaio, poltrona rivestita in skay, completo di lavandino colore bianco (lavandino squadrato art. K o lavandino tondo Art. P) e gruppo miscelatore.

Wash unit with steel structure, armchair covered in skay, complete with white sink (squared sink art. K or round sink art. P) and mixer unit.

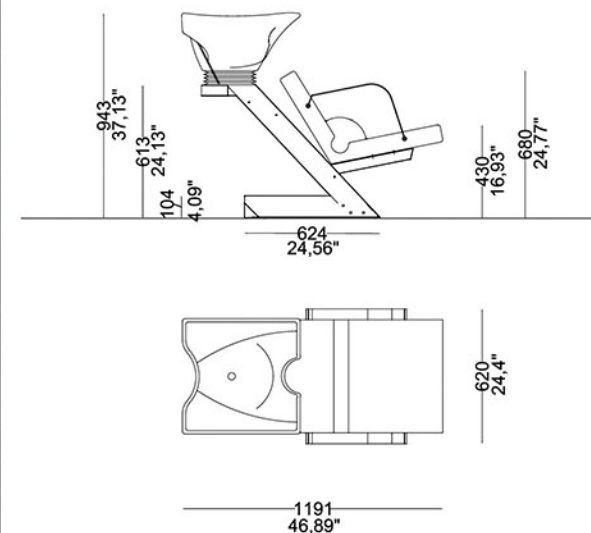

Mobile lavaggio con poltrona a scelta tra GM39/15K Charme, GM39/14P Aurora. Completo di lavandino e gruppo miscelatore

**PROMO 2020**

~~€ 1770,00~~

**€ 1150,00\***

**-35%**

\*incluso imballo, trasporto escluso  
possibilità di avere anche altri modelli di poltrone come da catalogo, non incluse nella promozione



## Colori Ecopelle



**Nero**  
cod. 00991



**Bianco**  
cod. 00006



**Marrone**  
cod. 01306

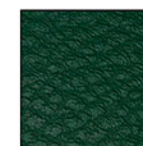

**Verde**  
cod. 01831

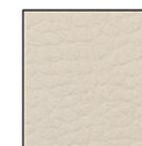

**Beige**  
cod. 00151



**Bordeaux**  
cod. 00726

# Salon Mirrors

GIGLI MASSIMO  
ITALY



# MIRAGE GM74

Postazione lavoro con struttura in legno, specchio sagomato, a un posto, con retroilluminazione led.

Workstation with structure made in wood, shaped mirror, with one place, with led backlight.

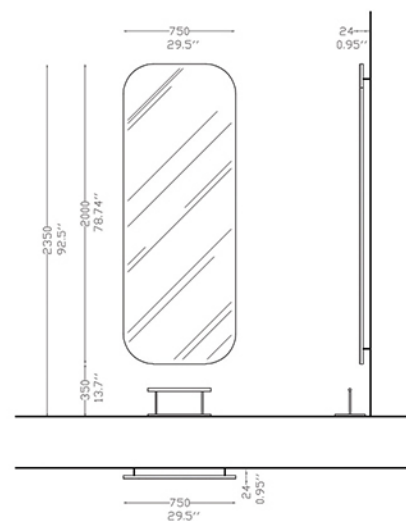

Postazione lavoro un posto completa di retroilluminazione a led

**PROMO 2020**

~~€ 1090,00~~

**€ 709,00\***

**-35%**

\*escluso poggiatesta autoportante.  
Incluso imballo, trasporto escluso

Laccatura opaca

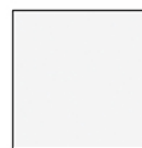

Bianco  
RAL 9010



Nero  
RAL 9005



Avorio  
RAL 1013

Laminati legno



Pino Svizzera  
cod. 01831

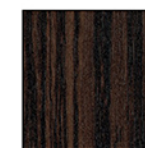

Dark Zebrano  
cod. 00151



Dark Rovere  
cod. 00726

# FACADE GM73

Postazione lavoro con struttura e piano in legno, con retroilluminazione led.

Workstation with structure and shelf made in wood, with led backlight.

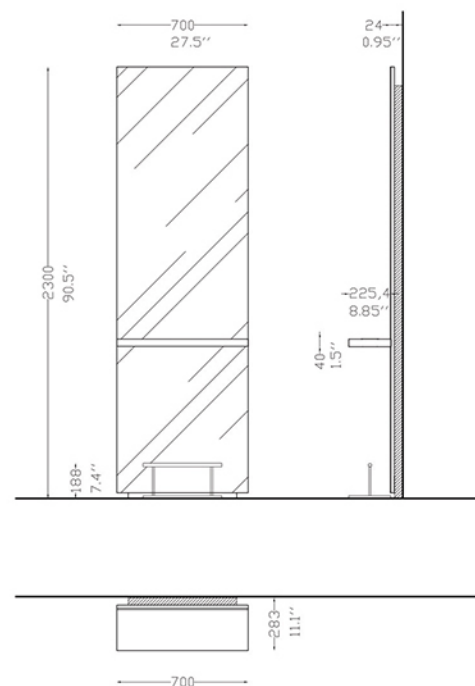

Postazione lavoro completa di retroilluminazione a led

**PROMO 2020**

~~€ 1320,00~~

**€ 858,00\***

**35%**

\*escluso poggiatesta autoportante.  
Incluso imballo, trasporto escluso

Laccatura opaca



Bianco  
RAL 9010



Nero  
RAL 9005



Avorio  
RAL 1013

Laminati legno



Pino Svizzera  
cod. 01831

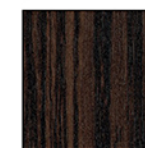

Dark Zebrano  
cod. 00151



Dark Rovere  
cod. 00726

## RETRO GM88

Tavolo tecnico quattro posti lavoro. Struttura in legno laminato o laccato, gamba in legno laccato. Completo di 4 specchi in appoggio.

Technical table four work places. Laminated or lacquered wood structure, lacquered wood leg. Complete with stand-in mirror.

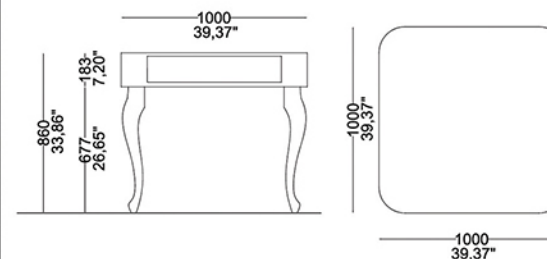

Tavolo tecnico completo di 4 specchi in appoggio

**PROMO 2020**

~~€ 3370,00~~

**€ 2190,00\***

**35%**

\*escluso poggiatesta autoportante.  
Incluso imballo, trasporto escluso

## LIBERTY GM89

Tavolo tecnico tre posti lavoro. Struttura in legno laminato o laccato, gamba in legno laccato. Completo di 3 specchi in appoggio.

Technical table three work places. Laminated or lacquered wood structure, lacquered wood leg. Complete with stand-in mirror.

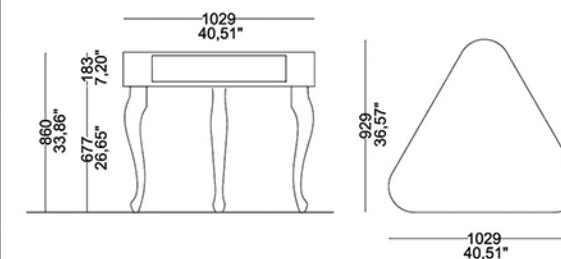

Postazione lavoro completo di 3 specchi in appoggio

**PROMO 2020**

~~€ 2315,00~~

**€ 1505,00\***

**35%**

\*escluso poggiatesta autoportante.  
Incluso imballo, trasporto escluso

Laccatura opaca



Bianco  
RAL 9010



Nero  
RAL 9005



Avorio  
RAL 1013

Laminati legno



Pino Svizzera  
cod. 01831

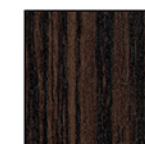

Dark Zebrano  
cod. 00151



Dark Rovere  
cod. 00726



# PLETTRO GM84

Postazione lavoro con specchio a filo lucido, completo di retroilluminazione a led.

Workstation with polished edge mirror with led backlight.

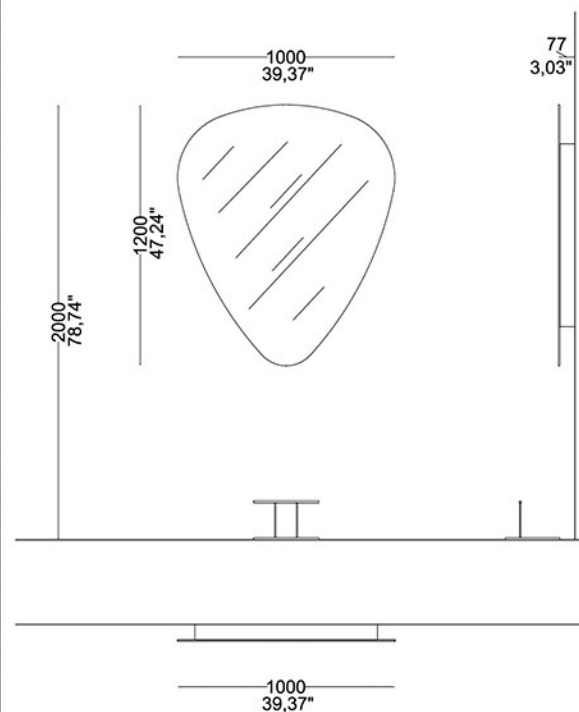

Postazione lavoro completa di retroilluminazione a led

**PROMO 2020**

~~€ 1045,00~~

**€ 680,00\***

**-35%**

\*escluso poggiatesta autoportante.  
Incluso imballo, trasporto escluso

Laccatura opaca

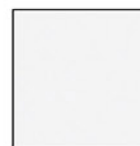

Bianco  
RAL 9010



Nero  
RAL 9005



Avorio  
RAL 1013

Laminati legno



Pino Svizzera  
cod. 01831

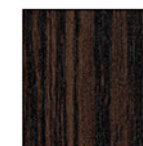

Dark Zebrano  
cod. 00151



Dark Rovere  
cod. 00726

# Cash Desk



# MONTE CRISTO GM 104

Mobile cassa con mobile frontale laccato, disponibili vari colori. Retro cassa in nobilitato attrezzato con cassetto e vani a giorno.

Cash Desk with the front lacquered, many colors available. Rear made in ennobled with one drawer and open spaces.

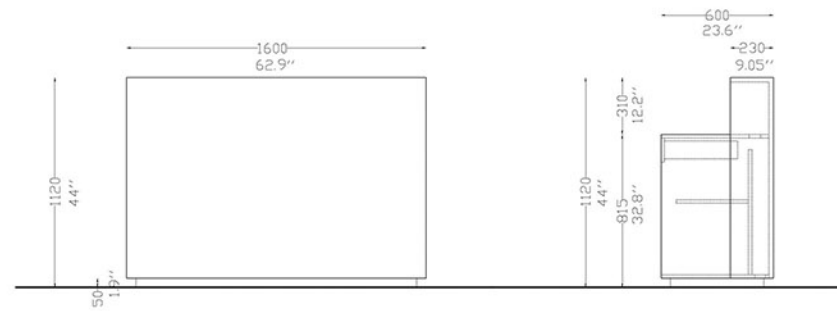

Mobile Cassa GM104/160 L.160 cm completo di balsa illuminata a led

**PROMO 2020**

~~€ 3650,00~~

**€ 2373,00\***

**-35%**

\*incluso imballo, trasporto escluso

Laccatura opaca



Bianco  
RAL 9010



Nero  
RAL 9005



Avorio  
RAL 1013

Laminati legno



Pino Svizzera  
cod. 01831

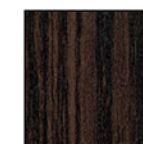

Dark Zebano  
cod. 00151



Dark Rovere  
cod. 00726

# TINO GM 107

Mobile cassa con mobile frontale laccato, disponibili vari colori. Retro cassa in nobilitato attrezzato con cassetto e vani a giorno.

Cash Desk with the front lacquered, many colors available. Rear made in ennobled with one drawer and open spaces.

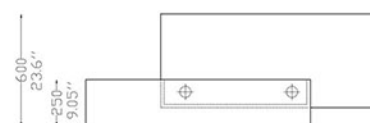
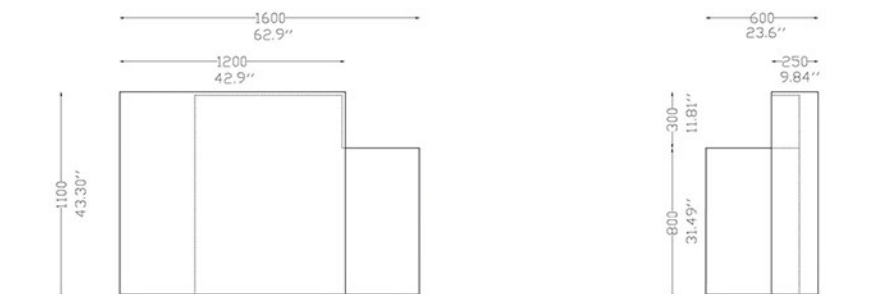

Mobile Cassa GM107/160 L. 160 cm

**PROMO 2020**

~~€ 4050,00~~

**€ 2633,00\***

**35%**

\*incluso imballo, trasporto escluso

Laccatura opaca



Bianco  
RAL 9010



Nero  
RAL 9005



Avorio  
RAL 1013

Laminati legno



Pino Svizzera  
cod. 01831

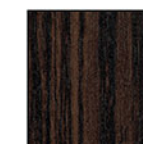

Dark Zebrano  
cod. 00151



Dark Rovere  
cod. 00726



# Service Furniture

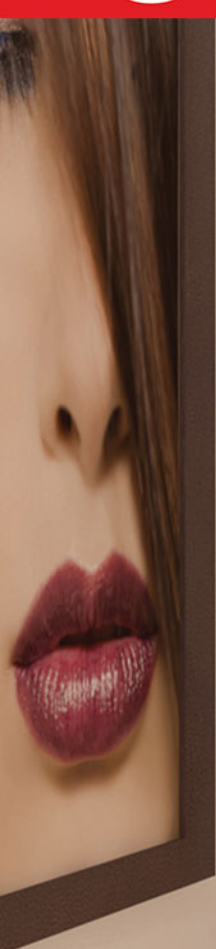

## MINIMAL GM130

Mobile di servizio retro lavaggio con due ante ed una bocca di lupo. Struttura in nobilitato laminato, ante e top laminato o laccato. Optional: GLDX - GLSX gruppo lavandino con miscelatore

Retro wash service cabinet with one doors and a wolf's mouth. Structure in laminated melamine, doors and top laminate or lacquered. Optional: GLDX - GLSX sink unit with mixer



MINIMAL - GM130/120

HALL - GM133/80

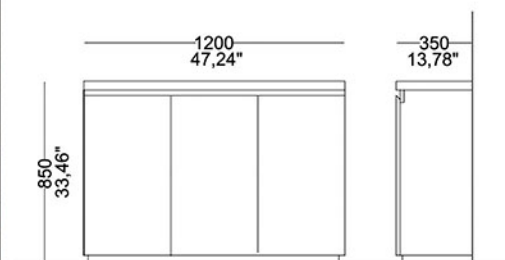

Mobile di servizio con 2 ante e 1 bocca di lupo - MINIMAL GM130/120 L.120 cm

**PROMO 2020**

~~€ 1760,00~~

**€ 1144,00\***

\*incluso imballo, trasporto escluso

**-35%**

Optional GLDX - GLSX: Lavandino con miscelatore ~~€ 360,00~~ **€ 234,00**

## ROUND GM131

Mobile di servizio retro lavaggio con due ante ed una bocca di lupo. Struttura in nobilitato laminato, ante e top laminato o laccato. Ante a sfilare con angoli stondati.

Optional: GLDX - GLSX gruppo lavandino con miscelatore

Retro wash service cabinet with one doors and a wolf's mouth. Structure in laminated melamine, doors and top laminate or lacquered. Optional: GLDX - GLSX sink unit with mixer



ROUND - GM131/120

ZEN - GM134/80

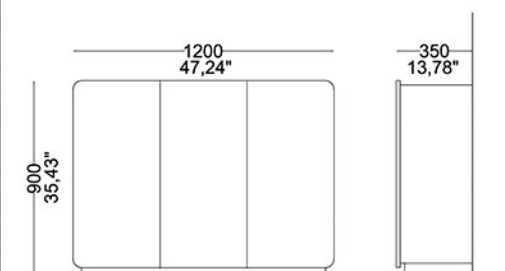

Mobile di servizio con 2 ante e 1 bocca di lupo - ROUND GM131/120 L.120 cm

**PROMO 2020**

~~€ 2300,00~~

**€ 1495,00\***

\*incluso imballo, trasporto escluso

**-35%**

Optional GLDX - GLSX: Lavandino con miscelatore ~~€ 360,00~~ **€ 234,00**

Laccatura opaca

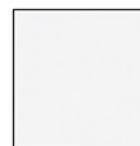

Bianco  
RAL 9010



Nero  
RAL 9005



Avorio  
RAL 1013

Laminati legno



Pino Svizzera  
cod. 01831

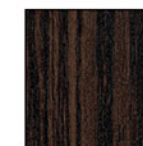

Dark Zebrano  
cod. 00151



Dark Rovere  
cod. 00726

# Barber Chair



**GIGLI & MASSIMO**  
ITALY

## DON GAETANO GM201

Poltrona uomo per Barber shop, con seduta e poggiatesta completamente reclinabile, con poggiatesta estraibile per eventuale utilizzo dello scivolo lavatesta, completa di pompa idraulica con base a disco.

Barber shop armchair, with fully reclining seat and footrest, with removable headrest for eventual use of the washing unit slide, complete with hydraulic pump with disc base.



GM201/S

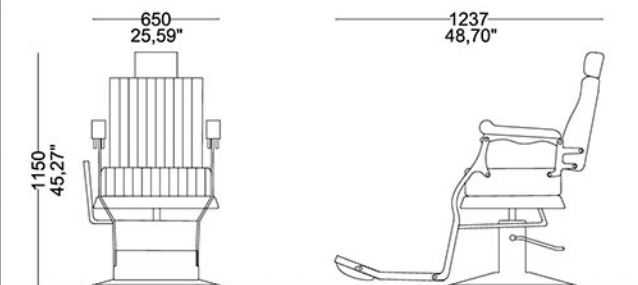

Poltrona reclinabile per BarberShop completa di poggiatesta estraibile e pompa idraulica con base a disco

**PROMO 2020**

~~€ 3890,00~~

**€ 2529,00\***

**-35%**

\*incluso imballo, trasporto escluso consegna 90 GG. salvo diversa comunicazione

Colori Ecopelle



Nero  
cod. 00991

Colori Bordo



Bianco  
cod. 00006



## CONDIZIONI DI VENDITA Italiano



**Ordini:** gli ordini si accettano solo ed esclusivamente per iscritto (posta elettronica e fax sono assimilabili) e divengono vincolati per Eurocomaco srl e per le parti quando Eurocomaco srl invia al cliente la conferma d'ordine.

**Prodotto:** Le caratteristiche dei prodotti illustrati nel catalogo non sono vincolanti. Ci riserviamo di eseguire tutte quelle variazioni che riterremo opportune, senza per altro darne avviso.

**Consegna/Titolo/Rischio:** il termine di consegna indicato nella conferma d'ordine è indicativo. Sono ammesse consegne parziali. La merce viaggia ad esclusivo rischio e pericolo del compratore, anche se venduta porto franco.

Eurocomaco srl non sarà responsabile del ritardo nell'adempimento delle sue obbligazioni (incluso il ritardo nella consegna) se tale ritardo sia causato da circostanze al di fuori del suo ragionevole controllo e avrà diritto a fruire di una estensione temporale per l'adempimento.

**Garanzia:** le vendite di cui alle presenti condizioni generali sono relative a PRODOTTI NON DESTINATI AI CONSUMATORI, quali individuati dall'articolo 3 del D.Lgs.206/2005.

**Durata:** Eurocomaco srl garantisce i prodotti per un anno dalla data di consegna.

La garanzia è esclusa se il vizio è provocato o accentuato da un uso non conforme del prodotto da parte del cliente o di terzi, ovvero da una manutenzione non conforme alle indicazioni del produttore, o da interventi di qualunque natura, anche manutentiva, sullo stesso non effettuati o non autorizzati da Eurocomaco srl.

**Pompe:** vengono garantite 24 mesi dalla data di consegna. Si consiglia di non muovere le poltrone dotate di pompa idraulica alzandole con presa sui braccioli.

**Skay/Vinyl:** non sono garantiti per i danni che non derivano da originari vizi di produzione, ma che sono conseguenza di fatti od eventi traumatici per il prodotto. Non può essere considerato vizio originario l'eventuale differenza di tonalità di colore che dovessero presentare articoli o prodotti aventi lo stesso tipo di materiale. Il processo di pulizia prevede l'utilizzo di acqua saponata da distribuirsi tramite mediante una spugna o un panno morbido.

**Parti verniciate e in alluminio:** non sono garantiti per i danni che non derivano da originari vizi di produzione, ma che sono conseguenza di fatti od eventi traumatici per il prodotto. Non può essere considerato vizio originario l'eventuale differenza di tonalità di colore che dovessero presentare articoli o prodotti aventi lo stesso tipo di materiale. Il processo di pulizia prevede l'utilizzo di acqua saponata da distribuirsi tramite mediante una spugna o un panno morbido.

**Neon, Led e Lampadine:** non rientrano nelle normali condizioni di garanzia, trattandosi di materiale di consumo. Il cliente è perciò tenuto ad una verifica immediata dei componenti e, ove riscontrasse una difformità, sarà tenuto a darne comunicazione scritta alla Eurocomaco srl entro e non oltre 8 giorni dal ricevimento della merce stessa; in mancanza, decade il diritto di garanzia.

**Rubinerie:** vengono garantite 24 mesi, le docce e i flessibili per mesi 6 e le cartucce in ceramica per mesi 12.

**Modalità d'intervento Eurocomaco srl:** l'azienda valuterà a proprio insindacabile giudizio se il problema rientra o meno nella copertura di garanzia commerciale. A seguito dell'esame del prodotto, si impegna alla sostituzione o riparazione dei pezzi che risultassero difettosi all'origine, che verranno resi franco fabbrica.

**Giurisdizione:** il presente contratto è regolato dalla legge italiana ed è soggetto alla giurisdizione esclusiva del Foro di Firenze.

**Promozione:** La vendita degli articoli oggetto di questa promozione non comprendono il servizio di progettazione piante tecniche e assistenza in loco di un nostro tecnico.

## TERMS OF SALE English



**Orders:** orders are accepted solely and exclusively in writing (email and fax are the same) and become binding for Eurocomaco srl and between the parties when Eurocomaco srl sends the order confirmation to the Customer.

**Product:** the product characteristics illustrated in the catalogue are not binding. We reserve the right to make all changes we consider appropriate, without any prior notice.

**Delivery/Title/Risk:** the delivery time indicated in the order confirmation is indicative. Partial deliveries are permitted. The goods travel at the exclusive risk and danger of the purchaser, even when sold carriage free.

Eurocomaco srl will not be liable for any delay in fulfilment of its obligations (included late delivery) if said delay is caused by circumstances beyond its reasonable control and will be entitled to an extension for fulfilment.

**Warranty:** this warranty is destined for Customers operating in their own professional activities, as in the definition in article 1.

The sales indicated in these general terms relate to PRODUCTS NOT DESTINED FOR CONSUMERS, as identified in article 3 of Legislative Decree 206/2005.

**Duration:** Eurocomaco srl guarantees the products for one year from the date of delivery. The warranty is excluded if the defect is caused or accentuated by improper use of the product by the Customer or third parties, or by the maintenance which does not conform with the manufacturer's indications, or interventions of any kind, including maintenance, on them which is not performed or not authorised by Eurocomaco srl.

**Pumps:** these are guaranteed for 24 months from the delivery date. It is recommended not to move chairs with hydraulic pumps by lifting them by the armrests.

**Skay/Vinyl:** this is not guaranteed against damages which do not derive from original manufacturing defects and/or poor quality of the materials used, but which are the consequence of traumatic facts or events for the product.

Any difference of color shade of articles or products with the same type of vinyl may not be considered as an original manufacturing defect. The cleaning process for synthetic upholstery requires use of soapy water to be distributed using a sponge or damp cloth.

**Paint and aluminium parts:** these are not guaranteed against damages which do not derive from original manufacturing defects and/or poor quality of the materials used, but which are the consequence of traumatic facts or events for the product.

The cleaning process for synthetic upholstery requires use of soapy water to be distributed using a sponge or damp cloth.

**Electric parts:** excluding neon, lights, leds and bulbs, there are covered by the general terms of warranty, provided the damage is not caused by sudden changes in voltage which exceed the limits indicated by CE regulations (220/240V, 50hz, +/- 10%)

**Taps, showers and hoses:** taps are guaranteed for 24 months, showers for 12 months and ceramic cartridges for 12 months.

**Eurocomaco srl intervention methods:** Eurocomaco srl will examine the product and will assess, as its own unquestionable discretion, whether or not the problem is covered by Eurocomaco srl warranty, through its own intervention service, and following examination, agrees to replace or repair items which are defective at origin, which will be returned ex works.

**Jurisdiction:** this contract is governed by Italian law and is subject to the exclusive jurisdiction of Firenze court.

**Promotion:** The sale of the items covered by this promotion do not include the technical plant design service and on-site assistance from one of our technicians.

**GIGLI&MASSIMO Italy**

distribuito da:

**EUROCOMACO S.R.L. Via G. Salvemini 9-9a Signa -FI- ITALIA**

**P.I. Iscr. Reg. Imprese Firenze n. 04945280487 REA n. 503530 Cap. Soc. Euro 15.600,00**

**Tel. 055.8728205 e-mail: [info@eurocomaco.it](mailto:info@eurocomaco.it) PEC: [eurocomaco@legalmail.it](mailto:eurocomaco@legalmail.it)**

**[www.eurocomaco.it](http://www.eurocomaco.it)**